



Ready... Set...
Install!

Internet: Gateway Installation Guide

Thanks for choosing Breezeline

We're excited to deliver our unlimited high-speed Internet and WiFi services directly to you. In this guide, you'll find everything you need to start utilizing our reliably fast Internet for all your working, video and streaming needs.

What's inside?

Removing your Equipment.....	3
Installing your Gateway.....	6
Connecting to WiFi.....	8
Installing your Phone.....	10



DON'T FEEL LIKE READING?

Scan this QR code with your smartphone to watch our installation video.

Or visit: breezeline.com/self-install-gateway

Before you begin

IMPORTANT STEP!



DO YOU HAVE YOUR PHONE SERVICE WITH BREEZELINE?

If you are a Breezeline Voice customer, you must call us at 1.888.674.4738 before disconnecting your phone modem. An agent will need to assist you in swapping your equipment to avoid an interruption to your phone service. If you don't receive phone service from Breezeline, you may proceed with these instructions.

How to remove your current equipment

1. If you have wireless devices connected to your current WiFi network, write down the wireless network name and password so that you can continue to use it after replacing your current modem. If you don't have the current wireless network name or password, you can create a new one later.

How to remove your current equipment (continued)

- Unplug your current modem from its power source. See diagram **A** below.
- Disconnect the coaxial cable line from the back of the wireless modem **B**. Do not disconnect the other end of the coaxial cable line from the wall or from any splitters.
- Disconnect any ethernet cord(s) from the current modem that are connected to any computers or other devices **C**. Do not disconnect the other end of the ethernet cord(s) from any connected computers or gaming devices.



Please Note: Your new Internet gateway has a built-in WiFi router, so you will not need to re-connect a standalone router, if you had one previously connected.

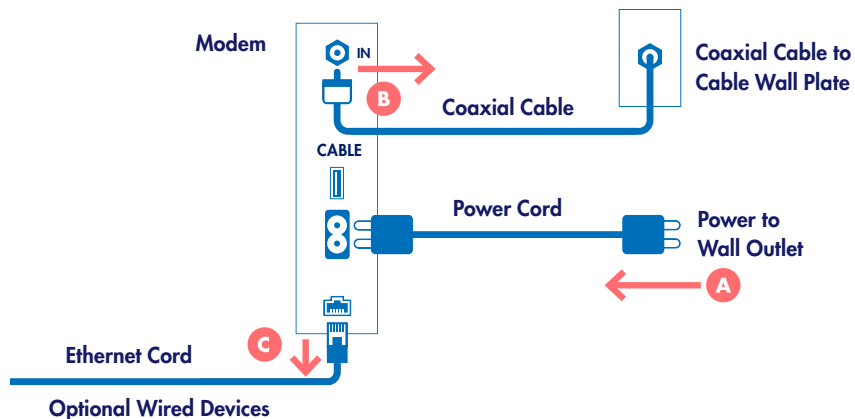

- Disconnect any ethernet cord(s) from the current modem that are connected to any computers or other devices **C**. Do not disconnect the other end of the ethernet cord(s) from any connected computers or gaming devices.
- ATTENTION PHONE CUSTOMERS: If you are a Breezeline Voice customer, you also will need to disconnect the phone lines from the back of the phone modem.** If you have more than one phone line, note which line was in port 1, and which was in port 2.
- DO YOU NEED TO RETURN YOUR EQUIPMENT?** We want to make it as easy as possible for you to return or recycle your old Breezeline-issued equipment. Please visit: breezeline.com/returns to check if your old equipment is eligible to be returned. If you do not see your equipment listed there, please take it to an electronics-recycling center for disposal.



START YOUR RETURN

Scan this QR code to access our returns page.



Please Note: If instructed to return your equipment to Breezeline and you fail to do so, a fee may be charged to your account.

- Please proceed to the "Installing your Gateway" section.

Getting your gateway connected

Follow these easy steps to set up your new internet service.

WHAT YOU'LL NEED

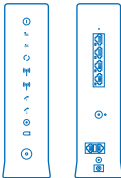

Gateway

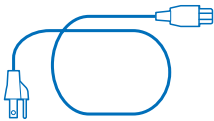

Power Cord

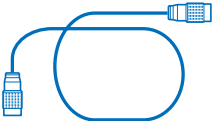

Coaxial Cable

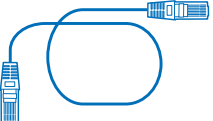

Ethernet Cord

Level of Difficulty:

 Easy

Time to Complete:

 Under 20 Min

Required Steps:

 8 Easy Steps

Note: If you have ordered Breezeline Voice service, you will also need a phone cord, which will be included. Please refer to page 10 for phone instructions.

How to set up your gateway

Follow the steps below to connect your new Breezeline Gateway, the all-in-one device that allows you to utilize both wired and wireless (WiFi) devices.

1. Locate a cable wall outlet (coaxial) in a central location. It will look like this: 
2. Connect coaxial cable from the wall to gateway **A** (insert into connector and turn barrel to tighten).
3. Connect power cord from gateway to the wall outlet **B**. The "US" and "DS" lights will flash simultaneously, as your gateway receives the latest updates. If after two minutes, the lights are not flashing, move to a different cable wall outlet and plug in. Updates being made may take 10-15 minutes to complete and your gateway must remain plugged in. Once the lights are glowing steady, it's ready to use.
4. If you're connecting a wired device, use the ethernet cord provided to connect the gateway to the back of the device **C**.

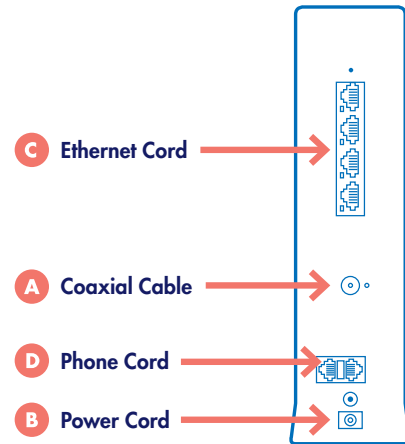

Note: If you're connecting Breezeline Voice service, use the phone cord to connect your phone to the gateway **D**.

Connect to your Gateway WiFi

To connect to your new WiFi network, you can keep the default WiFi network names and password OR you can rename them. To connect to the default WiFi network:

1. Look for the label on the bottom of your gateway (example shown here). You may see both 2.4GHz and 5GHz "SSIDs", as well as a "Pre-Shared Key" or password. Alternatively on some device labels the network name and password will be listed as the "Default WiFi Network" and the "Default Key".

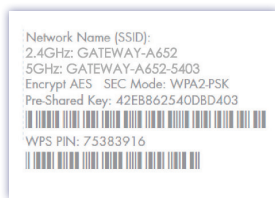

2. On the smartphone or laptop you wish to connect to WiFi, open "WiFi Settings."

3. Locate the 2.4GHz network name or the default WiFi network in your available WiFi networks list, and select it. Then input the "Pre-Shared Key" or default key password from your label. Your device is now connected to your home WiFi network!

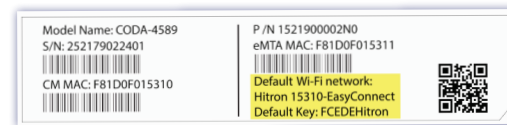

4. If you are not installing or reconnecting WiFi Your Way™ Home, you can connect all of your WiFi devices to your new home network by opening up the WiFi settings on each device, selecting the WiFi network name, and entering your WiFi password. Refer to Step 3 if you are using the default network name and password.

Note: To rename your new WiFi networks, please visit <https://192.168.0.1> from your browser when connected to your WiFi network and follow the on-screen instructions.



Tip: If you are also activating WiFi Your Way™ Home, follow the instructions on the WiFi Your Way™ Home "Ready Set Install Guide", and follow the instructions to complete your WiFi home network setup.

Getting your phone service connected

If you ordered Breezeline Voice, follow these easy instructions to set up your phone service.

WHAT YOU'LL NEED

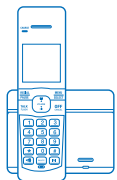

Phone

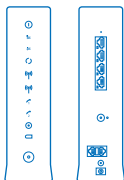

Gateway

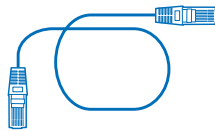

Phone Cord

Level of Difficulty:



Easy

Time to Complete:



5 Minutes

How to set up your phone

After connecting your Breezeline Gateway, follow these steps to connect your phone line. To get started you will need a phone and a phone cord.

Note: For this activation step, do not connect the gateway phone port to any wall phone jacks.

1. Connect the phone cord from your phone **A** into phone port #1 on the back of the gateway **B**.
2. You should now hear a dial tone.
3. From this phone, call the activation line at **1.888.674.4738** to complete the set up of your phone line and features. The activation team will assist you with connecting any additional phones.

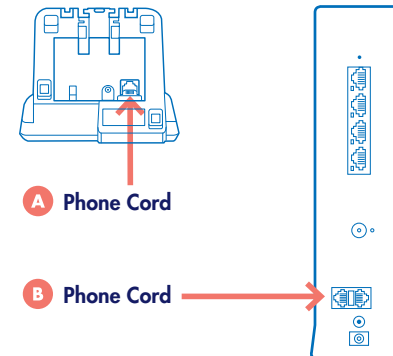



Need additional support?

Please visit breezeline.com/self-install-gateway to check out online resources including FAQs and set up videos.