

# Yealink

## Color-screen Expansion Module EXP50

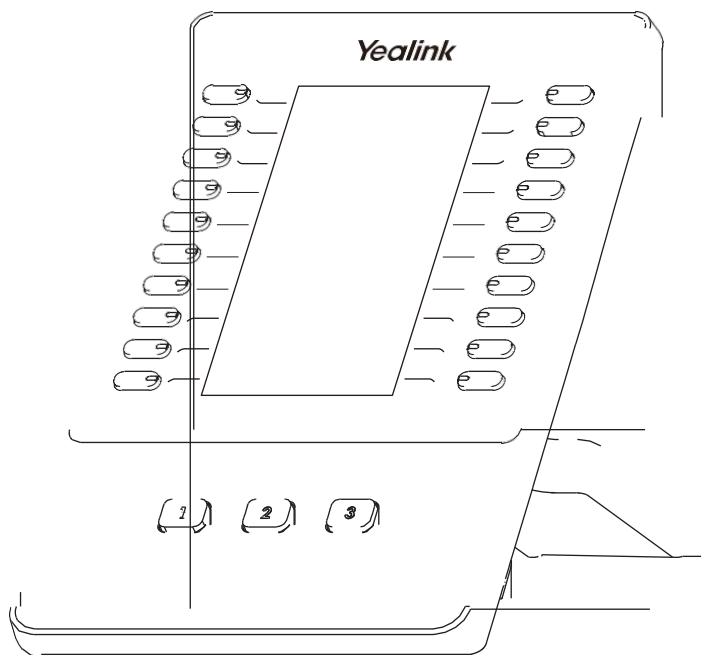

**Quick Start Guide (V1.3)**



## Package Contents

The following items are included in your package. If you find anything missing, contact your system administrator.

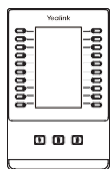

Color-screen



Stand



Connecting Sheet



USB Cable



Screwdriver



Screw



Quick Start Guide

Expansion Module

## Connecting to the Phone

1. Connect the EXP50 and the phone using the supplied screw and connecting sheet, as shown below:

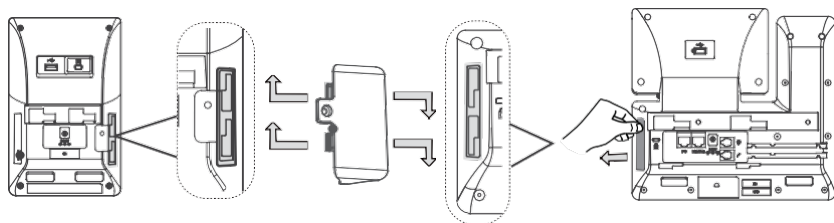

You may need to pull out the silica gel on the phone when connecting expansion module.

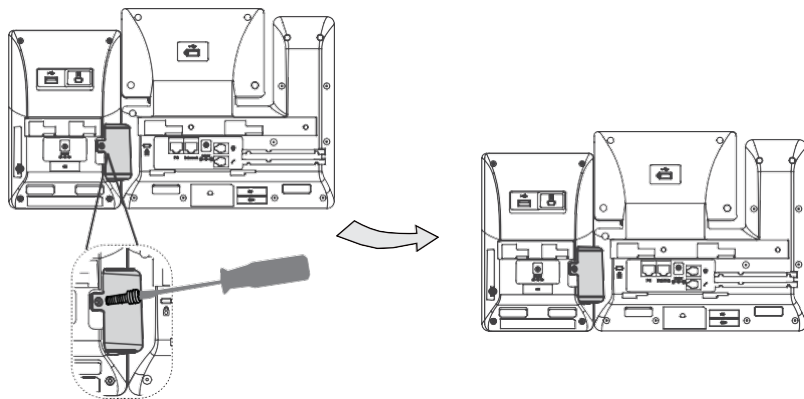

## Connecting two Expansion Modules

2. Follow the same step to connect two expansion modules:

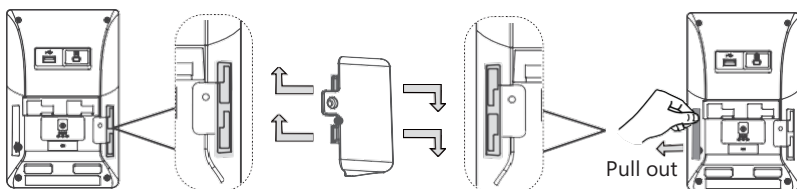

The slots are plugged up by silica gel. You can pull out the silica gel when cascading expansion modules.

**Your phone and the two expansion modules are connected as shown below:**

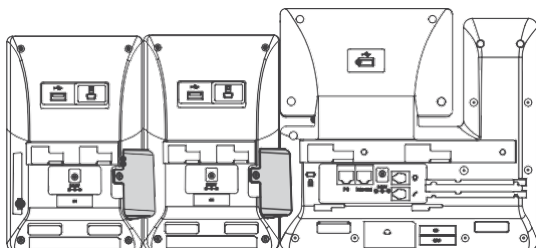

**Note:** The T53/T53W/T54W/T57W/T58A/T58A with camera IP phone can support 3 expansion modules at most. But if you use more than one expansion module, you need to connect an additional Yealink power adapter (5V/2A) to any one of the expansion modules. The power adapter should be purchased separately.

## Connecting the USB Cable

3. Connect the USB jack of the IP phone and the mini USB jack of the first module using a USB cable. If you want to connect another module, connect the USB jack of the first module and the mini USB jack of the second module using a USB cable.

As shown below:

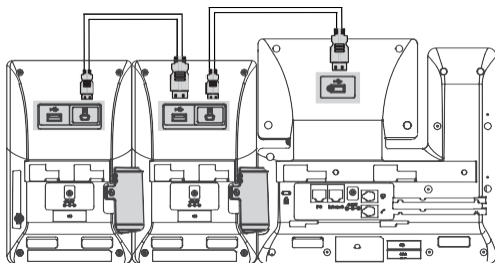

Connecting USB Cable

**Note:** You just need to connect the USB jack of the previous module and the mini USB jack of the next module using a USB cable.

Then you can attach the stand, the power adapter and the Ethernet cable to the phone, connect the handset and headset to use.

## Assembling the EXP50

Attach the stand, as shown below:

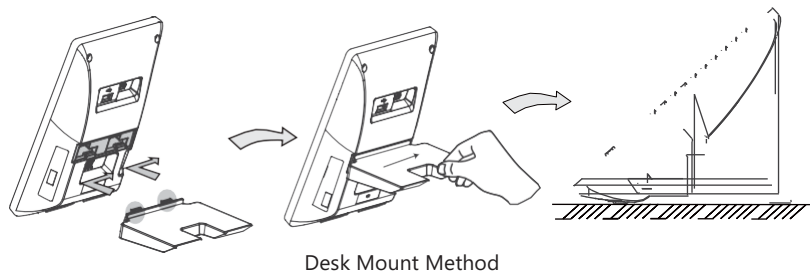

## Basic Configurations

The EXP50 supports 60 DSS keys in three screen pages. Each page displays 20 DSS keys. You can press **1**, **2** or **3** to switch to the corresponding page and use your desired DSS key.

You can assign a feature to a DSS key via phone user interface. Press the desired DSS key of EXP50 for about 5 seconds, the phone LCD screen will prompt the setting of this key. The following sections provide you with detailed instruction of assigning some frequently used features to the DSS keys via web user interface.

### Conference

The conference key allows you to set up a conference with a third party when already in a call.

1. Click on **Dsskey->Ext Key**.
2. In the desired DSS key field, select **Conference** from the pull-down list of **Type**.
3. Enter the phone number or extension of the destination party in the **Value** field.
4. (Optional.) Enter the string that will appear on the LCD screen in the **Label** field.
5. Click **Confirm** to accept the change.

### Forward

When there is an incoming call, you can press the forward key to forward the incoming call to the pre-defined destination number.

1. Click on **Dsskey->Ext Key**.
2. In the desired DSS key field, select **Forward** from the pull-down list of **Type**.
3. Enter the destination number to forward the incoming calls to in the **Value** field.
4. (Optional.) Enter the string that will appear on the LCD screen in the **Label** field.
5. Click **Confirm** to accept the change.

## Transfer

You can press the transfer key to perform a Blind/Semi-Attended/Attended transfer during a call.

1. Click on **Dsskey->Ext Key**.
2. In the desired DSS key field, select **Transfer** from the pull-down list of **Type**.
3. Enter the phone number you want to transfer the call to in the **Value** field.
4. (Optional.) Enter the string that will appear on the LCD screen in the **Label** field.
5. Click **Confirm** to accept the change.

## Hold

You can press the hold key to hold and retrieve a call.

1. Click on **Dsskey->Ext Key**.
2. In the desired DSS key field, select **Hold** from the pull-down list of **Type**.
3. (Optional.) Enter the string that will appear on the LCD screen in the **Label** field.
4. Click **Confirm** to accept the change.

## DND

You can press the DND key when the phone is idle to activate or deactivate the DND mode.

1. Click on **Dsskey->Ext Key**.
2. In the desired DSS key field, select **DND** from the pull-down list of **Type**.
3. (Optional.) Enter the string that will appear on the LCD screen in the **Label** field.
4. Click **Confirm** to accept the change.

## ReCall

You can place a call back to the caller of the last incoming call by pressing the ReCall key.

1. Click on **Dsskey->Ext Key**.
2. In the desired DSS key field, select **Recall** from the pull-down list of **Type**.
3. (Optional.) Enter the string that will appear on the LCD screen in the **Label** field.
4. Click **Confirm** to accept the change.

## SMS

You can access the SMS more quickly and easily by pressing the SMS key.

1. Click on **Dsskey->Ext Key**.
2. In the desired DSS key field, select **SMS** from the pull-down list of **Type**.
3. (Optional.) Enter the string that will appear on the LCD screen in the **Label** field.
4. Click **Confirm** to accept the change.

## Direct Pickup

If you press the direct pickup key when the specific phone number receives an incoming call, the call is answered on your phone.

1. Click on **Dsskey->Ext Key**.
2. In the desired DSS key field, select **Pickup** from the pull-down list of **Type**.
3. Enter the direct call pickup code followed by the specific number that you want to pick up a call from in the **Value** field.

4. (Optional.) Enter the string that will appear on the LCD screen in the **Label** field.
5. Select the desired line from the pull-down list of **Line**.
6. Click **Confirm** to accept the change.

## Group Pickup

You can pick up the incoming call of the pre-defined group by pressing the group pickup key.

1. Click on **Dsskey->Ext Key**.
2. In the desired DSS key field, select **Group Pickup** from the pull-down list of **Type**.
3. Enter the group call pickup code in the **Value** field.
4. (Optional.) Enter the string that will appear on the LCD screen in the **Label** field.
5. Select the desired line from the pull-down list of **Line**.
6. Click **Confirm** to accept the change.

## Call Park

You can park a call at an extension by pressing the call park key. The current call is put on hold and can be retrieved on another IP phone.

1. Click on **Dsskey->Ext Key**.
2. In the desired DSS key field, select **Call Park** from the pull-down list of **Type**.
3. Enter the call park code in the **Value** field.
4. (Optional.) Enter the string that will appear on the LCD screen in the **Label** field.
5. Select the desired line from the pull-down list of **Line**.
6. Click **Confirm** to accept the change.

## Voice Mail

You can access the voice mail more quickly by pressing the voice mail key.

1. Click on **Dsskey->Ext Key**.
2. In the desired DSS key field, select **Voice Mail** from the pull-down list of **Type**.
3. Enter the voice mail access code in the **Value** field.
4. (Optional.) Enter the string that will appear on the LCD screen in the **Label** field.
5. Select the desired line from the pull-down list of **Line**.
6. Click **Confirm** to accept the change.

## Speed Dial

You can speed up dialing the numbers which are frequently used or hard to remember by pressing the speed dial key.

1. Click on **Dsskey->Ext Key**.
2. In the desired DSS key field, select **SpeedDial** from the pull-down list of **Type**.
3. Enter the desired number you want to dial out directly in the **Value** field.
4. (Optional.) Enter the string that will appear on the LCD screen in the **Label** field.
5. Select the desired line from the pull-down list of **Line**.
6. Click **Confirm** to accept the change.

## Intercom

You can connect to the operator or the secretary more quickly by pressing the intercom key in an office environment .

1. Click on **Dsskey->Ext Key**.
2. In the desired DSS key field, select **Intercom** from the pull-down list of **Type**.
3. Enter the remote extension number in the **Value** field.
4. (Optional.) Enter the string that will appear on the LCD screen in the **Label** field.
5. Select the desired line from the pull-down list of **Line**.
6. Click **Confirm** to accept the change.

## Line

You can configure a DSS key as the line key. It performs the same as a hard line key.

1. Click on **Dsskey->Ext Key**.
2. In the desired DSS key field, select **Line** from the pull-down list of **Type**.
3. (Optional.) Enter the string that will appear on the LCD screen in the **Label** field.
4. Select the desired line from the pull-down list of **Line**.
5. Click **Confirm** to accept the change.

## BLF

The BLF key allows you to monitor the status of the pre-defined number. You can also pick up incoming calls of the monitored number.

1. Click on **Dsskey->Ext Key**.
2. In the desired DSS key field, select **BLF** from the pull-down list of **Type**.
3. Enter the phone number or extension you want to monitor in the **Value** field.
4. (Optional.) Enter the string that will appear on the LCD screen in the **Label** field.
5. Select the desired line from the pull-down list of **Line**.
6. Enter the directed call pickup code in the **Extension** field.
7. Click **Confirm** to accept the change.

## Group Listening

You can configure a DSS key as the group listening key. Then you are allowed to activate the Speakerphone and Handset/Headset at the same time by pressing the group listening key.

1. Click on **Dsskey->Ext Key**.
2. In the desired DSS key field, select **Group Listening** from the pull-down list of **Type**.
3. (Optional.) Enter the string that will appear on the LCD screen in the **Label** field.
4. Click **Confirm** to accept the change.



## regulatory notices

### Operating Ambient Temperatures

- Operating temperature: +32 to 104°F (0 to 40°C)
- Relative humidity: 5% to 90%, noncondensing
- Storage temperature: -22 to +160°F (-30 to +70°C)

### Warranty

Our product warranty is limited only to the unit itself, when used normally in accordance with the operating instructions and the system environment. We are not liable for damage or loss resulting from the use of this product, or for any claim from a third party. We are not liable for problems with Yealink device arising from the use of this product; we are not liable for financial damages, lost profits, claims from third parties, etc., arising from the use of this product.

### Explanation of the symbols

#### ● DC symbol

— is the DC voltage symbol.

#### ● WEEE Warning symbol

⚠ To avoid the potential effects on the environment and human health as a result of the presence of hazardous substances in electrical and electronic equipment, end users of electrical and electronic equipment should understand the meaning of the crossed-out wheeled bin symbol. Do not dispose of WEEE as unsorted municipal waste and have to collect such WEEE separately.

### Restriction of Hazardous Substances Directive (RoHS)

This device complies with the requirements of the EU RoHS Directive. Statements of compliance can be obtained by contacting support@yealink.com.

### Safety Instructions

Save these instructions. Read these safety instructions before use!

#### ⚠ General Requirements

- Before you install and use the device, read the safety instructions carefully and observe the situation during operation.
- During the process of storage, transportation, and operation, please always keep the device dry and clean, avoid collision and crash.
- Please attempt not to dismantle the device by yourself. In case of any discrepancy, please contact the appointed maintenance center for repair.
- Please refer to the relevant laws and statutes while using the device. Legal rights of others should be respected as well.

#### ⚠ Environmental Requirements

- Place the device at a well-ventilated place. Do not expose the device under direct sunlight.
- Keep the device dry and free of dusts.
- Do not place the device on or near any inflammable or fire-vulnerable object, such as rubber-made materials.
- Keep the device away from any heat source or bare fire, such as a candle or an electric heater.

#### ⚠ Operating Requirements

- Do not let a child operate the device without guidance.
- Do not let a child play with the device or any accessory in case of accidental swallowing.
- Please use the accessories provided or authorized by the manufacturer only.
- The power supply of the device shall meet the requirements of the input voltage of the device. Please use the provided surge protection power socket only.
- Before plugging or unplugging any cable, make sure that your hands are completely dry.
- Do not spill liquid of any kind on the product or use the equipment near water, for example, near a bathtub, washbowl, kitchen sink, wet basement or near a swimming pool.
- During a thunderstorm, stop using the device and disconnect it from the power supply. Unplug the power plug and the Asymmetric Digital Subscriber Line (ADSL) twisted pair (the radio frequency cable) to avoid lightning strike.

## About Yealink

Yealink is a global leading provider of enterprise communication and collaboration solutions, offering video conferencing service to worldwide enterprises. Focusing on research and development, Yealink also insists on innovation and creation. With the outstanding technical patents of cloud computing, audio, video and image processing technology, Yealink has built up a panoramic collaboration solution of audio and video conferencing by merging its cloud services with a series of endpoints products. As one of the best providers in more than 140 countries and regions including the US, the UK and Australia, Yealink ranks No.1 in the global market share of SIP phones shipments.

## Technical Support

Visit Yealink WIKI (<http://support.yealink.com/>) for the latest firmware, guides, FAQ, Product documents, and more. For better service, we sincerely recommend you to use Yealink Ticketing system (<https://ticket.yealink.com/>) to submit all your technical issues.



EXP50-EN

- power supply and unplug the power plug.
- When there is smoke emitted from the device, or some abnormal noise or smell, disconnect the device from the power supply, and unplug the power plug immediately.
- Contact the specified maintenance center for repair.
- Do not insert any object into equipment slots that is not part of the product or auxiliary product.
- Before connecting a cable, connect the grounding cable of the device first. Do not disconnect the grounding cable until you disconnect all other cables.

#### ⚠ Cleaning Requirements

- Before cleaning the device, disconnect it from the power supply.
- Use a piece of soft, dry and anti-static cloth to clean the device.
- Keep the power plug clean and dry.

## Troubleshooting

The unit cannot supply power to Yealink device.

There is a bad connection with the plug.

1. Clean the plug with a dry cloth.
  2. Connect it to another wall outlet.
- The usage environment is out of operating temperature range.
1. Use in the operating temperature range.

The cable between the unit and the Yealink device is connected incorrectly.

1. Connect the cable correctly.
- You cannot connect the cable properly.
1. You may have connected a wrong Yealink device.
  2. Use the correct power supply.

Some dust, etc., may be in the port.

1. Clean the port.
- Contact your dealer or authorized service facility for any further questions.

## FCC Statement

This device complies with part 15 of the FCC Rules. Operation is subject to the following

two conditions: (1) this device may not cause harmful interference, and (2) this device must accept any interference received, including interference that may cause undesired operation.

Any Changes or modifications not expressly approved by the party responsible for compliance could void the user's authority to operate the equipment.

## IC Statement

This device complies with Industry Canada's licence-exempt RSSs. Operation is subject to the following two conditions:

(1) this device may not cause interference; and

(2) this device must accept any interference, including interference that may cause undesired operation of the device. CANICES-3(B)

Le présent appareil est conforme aux CNR d'Industrie Canada applicables aux appareils radio exempts de licence. L'exploitation est autorisée aux deux conditions suivantes :

(1) l'appareil ne doit pas produire de brouillage;

(2) l'utilisateur de l'appareil doit accepter tout brouillage radioélectrique subi, même si le brouillage est susceptible d'en compromettre le fonctionnement. NMB-3(B)

## Contact Information

YEALINK NETWORK TECHNOLOGY CO.,LTD.

309, 3rd Floor, No.16, Yun Ding North Road, Huli District, Xiamen City, Fujian, P.R. China

YEALINK (EUROPE) NETWORK TECHNOLOGY B.V.

Strawinskylaan 3127, Atrium Building, 8th floor, 1077ZX Amsterdam, The Netherlands

YEALINK (USA) NETWORK TECHNOLOGY CO., LTD.

999 Peachtree Street Suite 2300, Fulton, Atlanta, GA, 30309, USA

Made in China



YEALINK(XIAMEN) NETWORK TECHNOLOGY CO.,LTD.

Web: [www.yealink.com](http://www.yealink.com)

Copyright©2019 YEALINK(XIAMEN) NETWORK

TECHNOLOGY CO.,LTD.All rights reserved.